

W360 Animal Health UVA / UVB Light

30W LED / 55°



- Broadband UVA for Animal Health
- UVB for Reptile Vitamin D3 Synthesis
- Adjustable Intensity
- DMX Controllable
- Also Available with Other Optics

ORDERING GUIDE

CXW360BD - **UVBA** - - - -

Spectrum

UVBA UVBA

Finish

WH White
BK Black

Mount

TOX w/ O-type DMX Track Adapter
TON w/ O-type Non-DMX Track Adapter
CLP w/ Clamp Mount
MPT w/ Monopoint Adapter Mount (PSX+120V only)

Power Supply & Control

PS Power Supply



PSX Power Supply w/ DMX
(compatible with TOX/MPT mount)



Plug/Connection

US US 120V
EU EU 220V

SPECIFICATIONS

Beam Angle	55°
Spectrum Type	UVBA
Control	Intensity (0% - 100%)
LED Source	DiCon Dense Matrix LED
Power Draw	AC 30W max
AC Input Voltage	100 - 240V AC, 60Hz
Cooling	Fan Cooled
Operating Temperature	32 - 104°F (0 - 40°C)
Fixture Weight	1.3lb (0.6kg)
Power Supply Weight	1.0lb (0.4kg)

MECHANICAL FIGURES

W360BD-TOX/TON

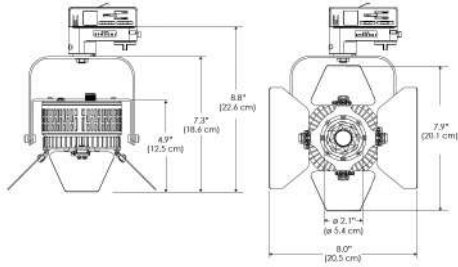

PS **US**

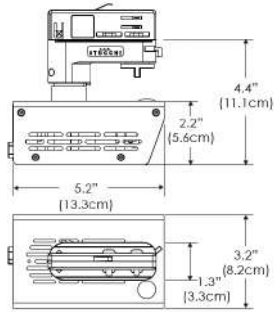

PSX **US**

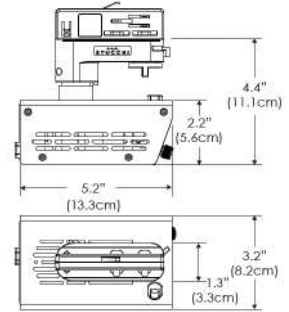

W360BD-TOX/TON

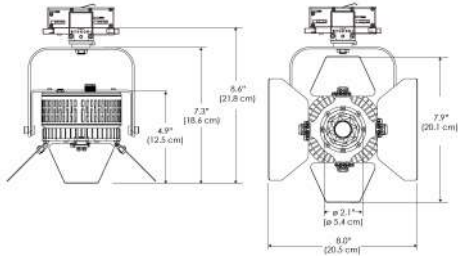

PS **EU**

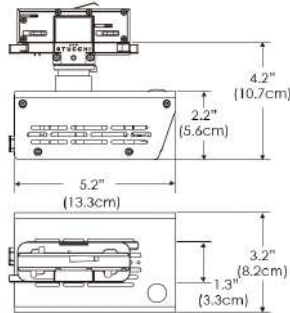

PSX **EU**

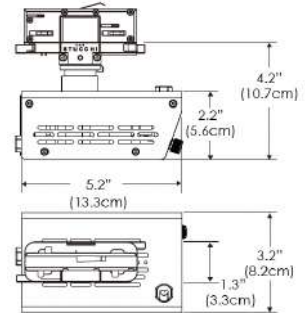

W360BD-CLP

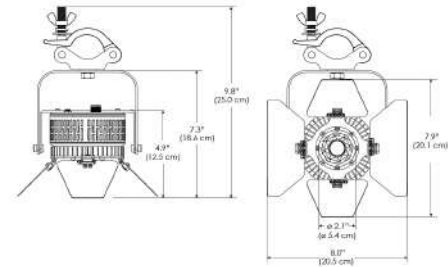

PS **US EU**

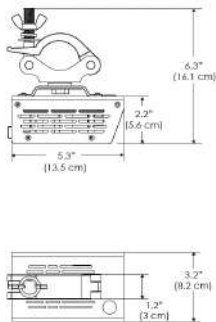

Mounting Bracket Dimensions ALL-CLP

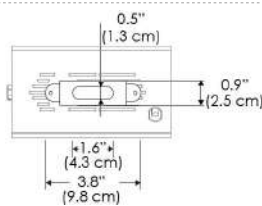

*All -CLP configuration models come with standard DC cables of 6" and AC cables of 10'.

W360BD-MPT

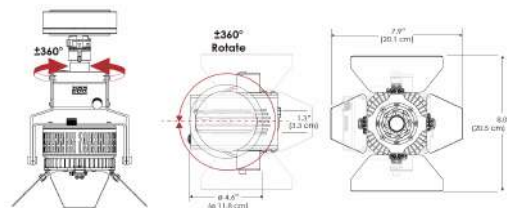

PSX **US**

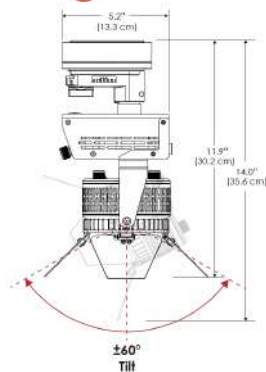

PSX **EU**

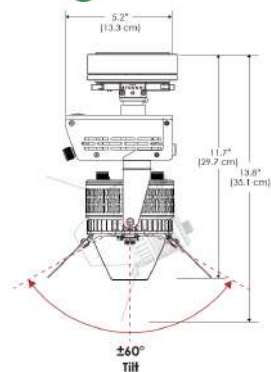

PHOTOMETRIC DATA

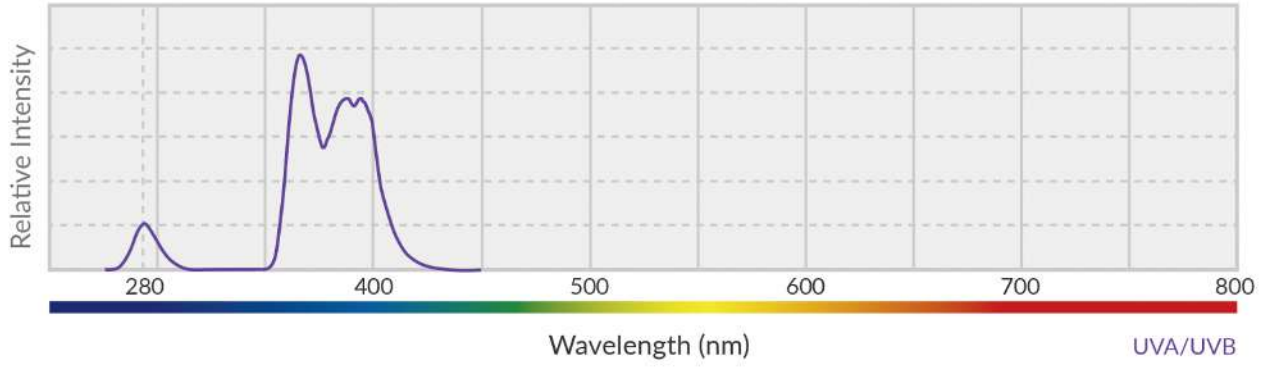

Distance	1' (~0.3 m)	3' (~0.9 m)	5' (~1.5 m)
Total UV	3302	338	116
UVA	2980	314	108
UVB	322	24	7
Beam Diameter	Ø 2.3' (0.7m)	Ø 7.1' (2.2m)	Ø 11.6' (3.5m)